

Dave Andrews

Chief Architect

The Media Platform at Verizon Media

 @daveisangry @engage_vdms

<https://eng.vdms.com>

Which Edge do you need?

Managing multiple edges to deliver the next industrial revolution

The 'Edge'

A Brief History

Early internet



The 'Edge'

A Brief History

1996

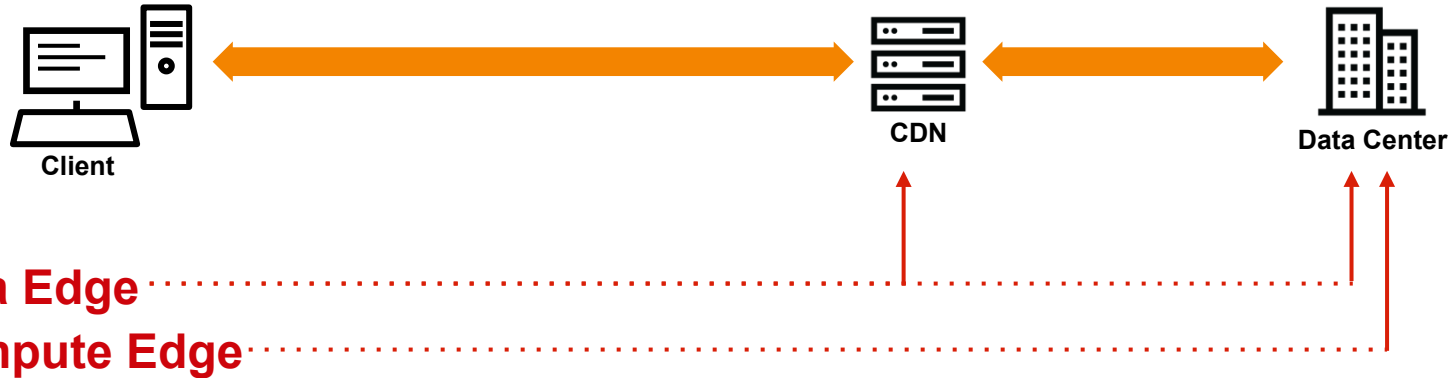

The 'Edge'

A Brief History

2006



Data Edge

Compute Edge

The 'Edge'

A Brief History

2007

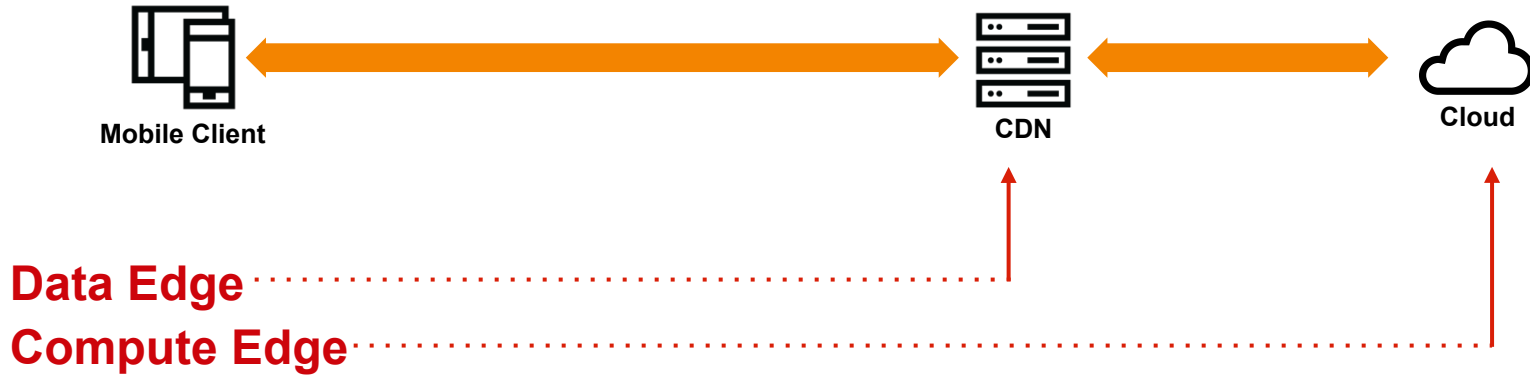

The 'Edge'

A Brief History

2017

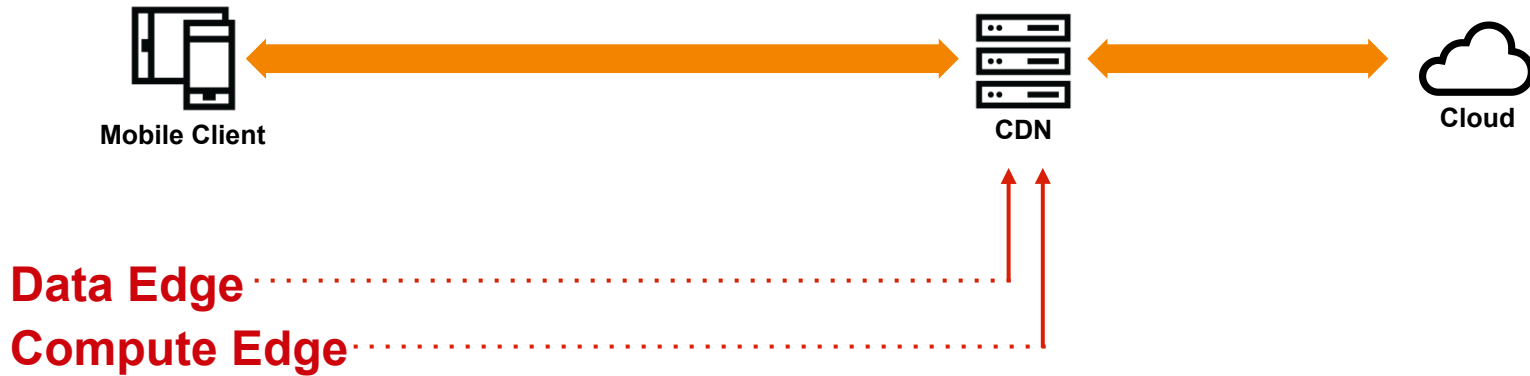

The 'Edge'

Next...

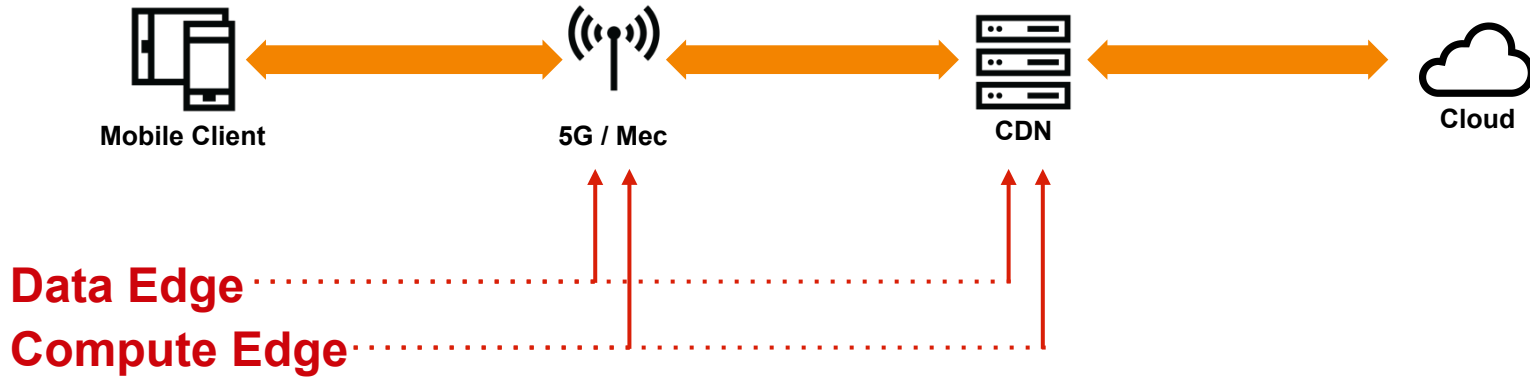

The 'Edge'

Next...

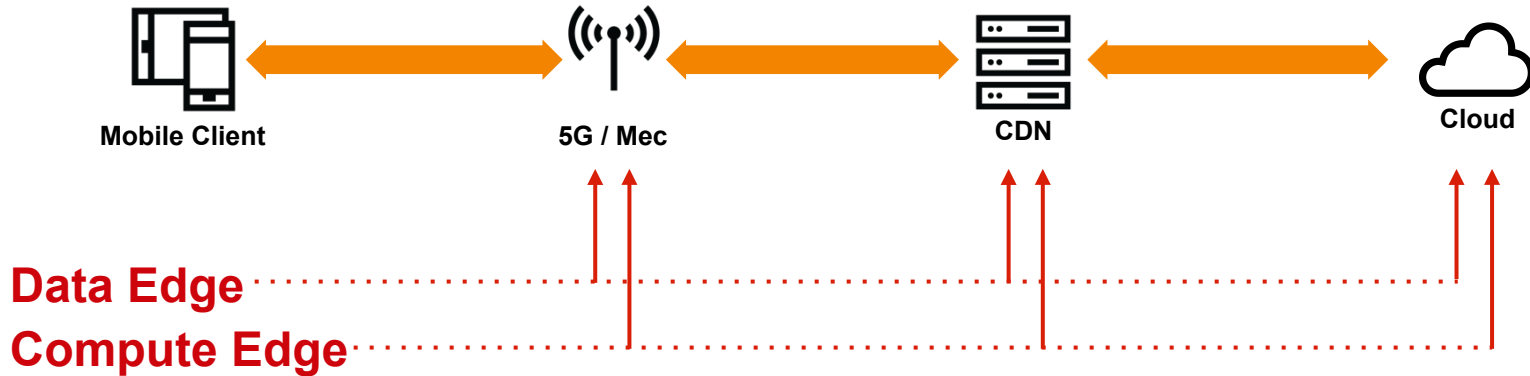

The 'Edge'

Concentric Circles



Data Edge

Compute Edge

The 'Edge'

Concentric Circles



Latency
Compute
Storage

The 'Edge'

Concentric Circles

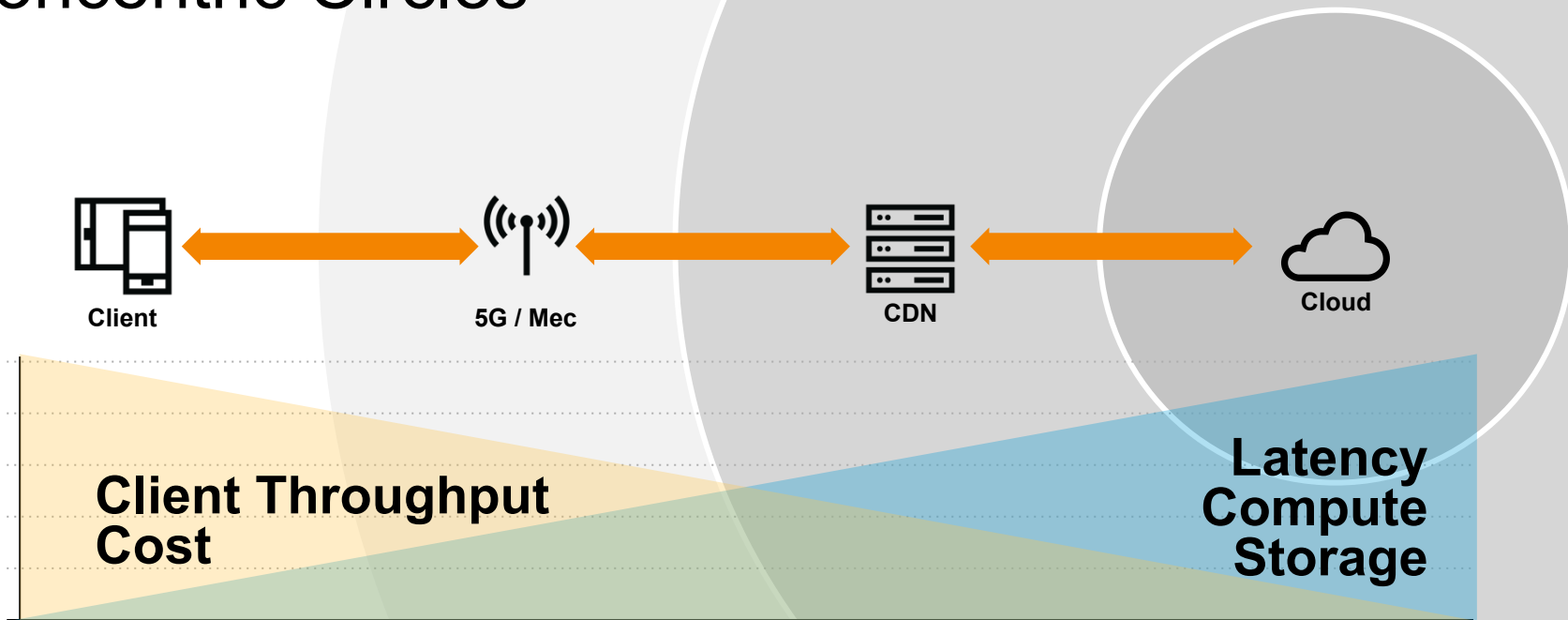

What do you see in this new ecosystem?

- Lots of interesting low-latency use-cases
- Problems, problems everywhere! Technology fragmentation, lack of interoperability, new intricate failure modes, increased operational complexity, and more...
- The potential for a cohesive system that empowers people to use all of these rings together
- Enabling new capabilities, for example distributed real-time computing

So, to sum up:

“Which Edge do you need?”

All of them. , but acting as one.

Thanks.

Thanks.



So to sum up:

“Which Edge do you need?”

All of them, but acting as one.

Thanks

The 'Edge'

A Brief History

next...

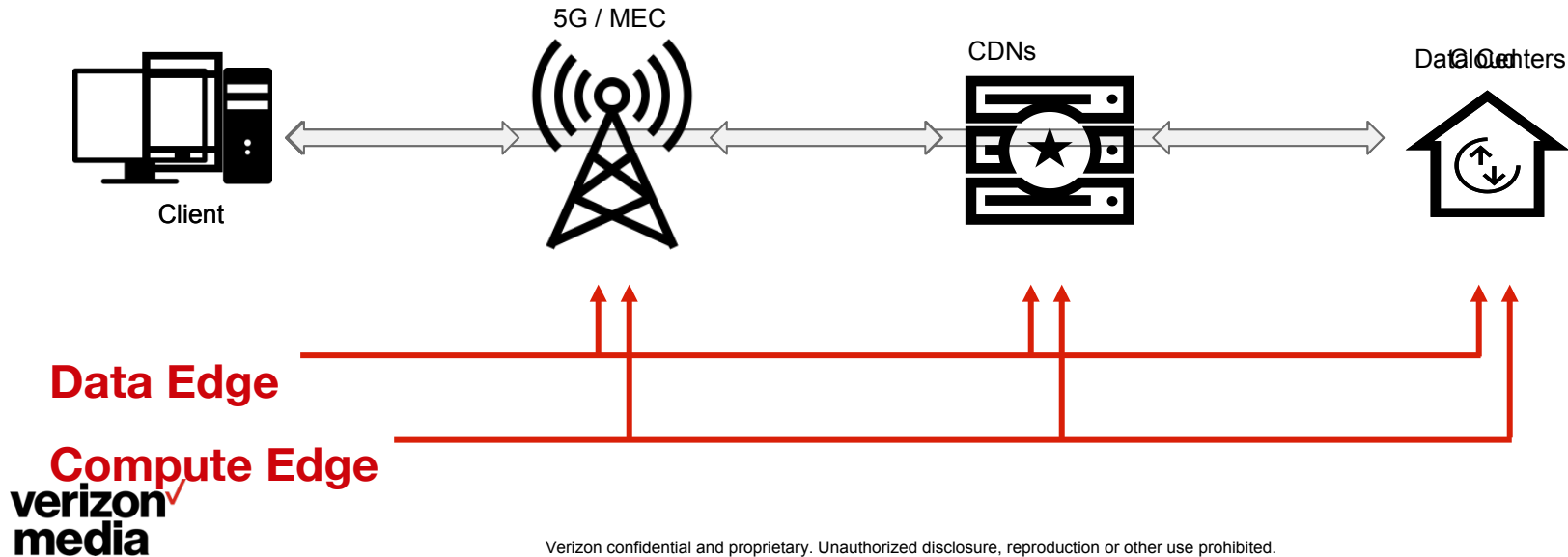

The 'Edge'

Concentric Circles

